

System 300S

PS | 307-1xA00 | Manual

HB130 | PS | 307-1xA00 | en | 18-02

PS 307



YASKAWA Europe GmbH
Philipp-Reis-Str. 6
65795 Hattersheim
Germany
Tel.: +49 6196 569-300
Fax: +49 6196 569-398
Email: info@yaskawa.eu
Internet: www.yaskawa.eu.com

Table of contents

1	General	4
1.1	Copyright © YASKAWA Europe GmbH.....	4
1.2	About this manual.....	5
1.3	Safety information.....	6
2	Assembly and installation guidelines	7
2.1	Safety information for users.....	7
2.2	Installation dimensions.....	8
2.3	Installation at the profile rail.....	9
2.4	Cabling.....	11
2.5	Installation guidelines.....	12
2.6	General data.....	14
2.6.1	Use in difficult operating conditions.....	15
3	Power supply PS 307	16
3.1	Safety Information.....	16
3.2	System overview.....	17
3.3	PS 307-1BA00.....	18
3.3.1	Technical data.....	21
3.4	PS 307-1EA00.....	23
3.4.1	Technical data.....	27
3.5	PS 307-1KA00.....	29
3.5.1	Technical data.....	33

1 General

1.1 Copyright © YASKAWA Europe GmbH

All Rights Reserved

This document contains proprietary information of Yaskawa and is not to be disclosed or used except in accordance with applicable agreements.

This material is protected by copyright laws. It may not be reproduced, distributed, or altered in any fashion by any entity (either internal or external to Yaskawa) except in accordance with applicable agreements, contracts or licensing, without the express written consent of Yaskawa and the business management owner of the material.

For permission to reproduce or distribute, please contact: YASKAWA Europe GmbH, European Headquarters, Philipp-Reis-Str. 6, 65795 Hattersheim, Germany

Tel.: +49 6196 569 300

Fax.: +49 6196 569 398

Email: info@yaskawa.eu

Internet: www.yaskawa.eu.com



Every effort has been made to ensure that the information contained in this document was complete and accurate at the time of publishing. Nevertheless, the authors retain the right to modify the information.

This customer document describes all the hardware units and functions known at the present time. Descriptions may be included for units which are not present at the customer site. The exact scope of delivery is described in the respective purchase contract.

EC conformity declaration

Hereby, YASKAWA Europe GmbH declares that the products and systems are in compliance with the essential requirements and other relevant provisions. Conformity is indicated by the CE marking affixed to the product.

Conformity Information

For more information regarding CE marking and Declaration of Conformity (DoC), please contact your local representative of YASKAWA Europe GmbH.

Trademarks

VIPA, SLIO, System 100V, System 200V, System 300V, System 300S, System 400V, System 500S and Commander Compact are registered trademarks of YASKAWA Europe GmbH.

SPEED7 is a registered trademark of YASKAWA Europe GmbH.

SIMATIC, STEP, SINEC, TIA Portal, S7-300, S7-400 and S7-1500 are registered trademarks of Siemens AG.

Microsoft and Windows are registered trademarks of Microsoft Inc., USA.

Portable Document Format (PDF) and Postscript are registered trademarks of Adobe Systems, Inc.

All other trademarks, logos and service or product marks specified herein are owned by their respective companies.

Document support

Contact your local representative of YASKAWA Europe GmbH if you have errors or questions regarding the content of this document. You can reach YASKAWA Europe GmbH via the following contact:

Email: Documentation.HER@yaskawa.eu

Technical support

Contact your local representative of YASKAWA Europe GmbH if you encounter problems or have questions regarding the product. If such a location is not available, you can reach the Yaskawa customer service via the following contact:

YASKAWA Europe GmbH,
European Headquarters, Philipp-Reis-Str. 6, 65795 Hattersheim, Germany
Tel.: +49 6196 569 500 (hotline)
Email: support@yaskawa.eu

1.2 About this manual

Objective and contents

This manual describes the power supplies for the System 300 from Yaskawa. It contains a description of the construction, usage and technical data.

Product	Order number	as of HW state
PS 307	307-1xA00	01

Target audience

The manual is targeted at users who have a background in automation technology.

Structure of the manual

The manual consists of chapters. Every chapter provides a self-contained description of a specific topic.

Guide to the document

The following guides are available in the manual:

- An overall table of contents at the beginning of the manual
- References with page numbers

Availability

The manual is available in:

- printed form, on paper
- in electronic form as PDF-file (Adobe Acrobat Reader)

Icons Headings

Important passages in the text are highlighted by following icons and headings:

**DANGER!**

Immediate or likely danger. Personal injury is possible.

**CAUTION!**

Damages to property is likely if these warnings are not heeded.



Supplementary information and useful tips.

1.3 Safety information

Applications conforming with specifications

The system is constructed and produced for:

- communication and process control
- general control and automation tasks
- industrial applications
- operation within the environmental conditions specified in the technical data
- installation into a cubicle



DANGER!

This device is not certified for applications in

- in explosive environments (EX-zone)

Documentation

The manual must be available to all personnel in the

- project design department
- installation department
- commissioning
- operation



CAUTION!

The following conditions must be met before using or commissioning the components described in this manual:

- Hardware modifications to the process control system should only be carried out when the system has been disconnected from power!
- Installation and hardware modifications only by properly trained personnel.
- The national rules and regulations of the respective country must be satisfied (installation, safety, EMC ...)

Disposal

National rules and regulations apply to the disposal of the unit!

2 Assembly and installation guidelines

2.1 Safety information for users

Handling of electrostatic sensitive modules

The modules make use of highly integrated components in MOS-Technology. These components are extremely sensitive to over-voltages that can occur during electrostatic discharges. The following symbol is attached to modules that can be destroyed by electrostatic discharges.



The Symbol is located on the module, the module rack or on packing material and it indicates the presence of electrostatic sensitive equipment. It is possible that electrostatic sensitive equipment is destroyed by energies and voltages that are far less than the human threshold of perception. These voltages can occur where persons do not discharge themselves before handling electrostatic sensitive modules and they can damage components thereby, causing the module to become inoperable or unusable. Modules that have been damaged by electrostatic discharges can fail after a temperature change, mechanical shock or changes in the electrical load. Only the consequent implementation of protection devices and meticulous attention to the applicable rules and regulations for handling the respective equipment can prevent failures of electrostatic sensitive modules.

Shipping of modules

Modules must be shipped in the original packing material.

Measurements and alterations on electrostatic sensitive modules

When you are conducting measurements on electrostatic sensitive modules you should take the following precautions:

- Floating instruments must be discharged before use.
- Instruments must be grounded.

Modifying electrostatic sensitive modules you should only use soldering irons with grounded tips.



CAUTION!

Personnel and instruments should be grounded when working on electrostatic sensitive modules.

2.2 Installation dimensions

Dimensions Basic enclosure

- 1tier width (WxHxD) in mm: 40 x 125 x 120
- 1tier width (WxHxD) in mm: 80 x 125 x 120
- 1tier width (WxHxD) in mm: 120 x 125 x 120

Dimensions

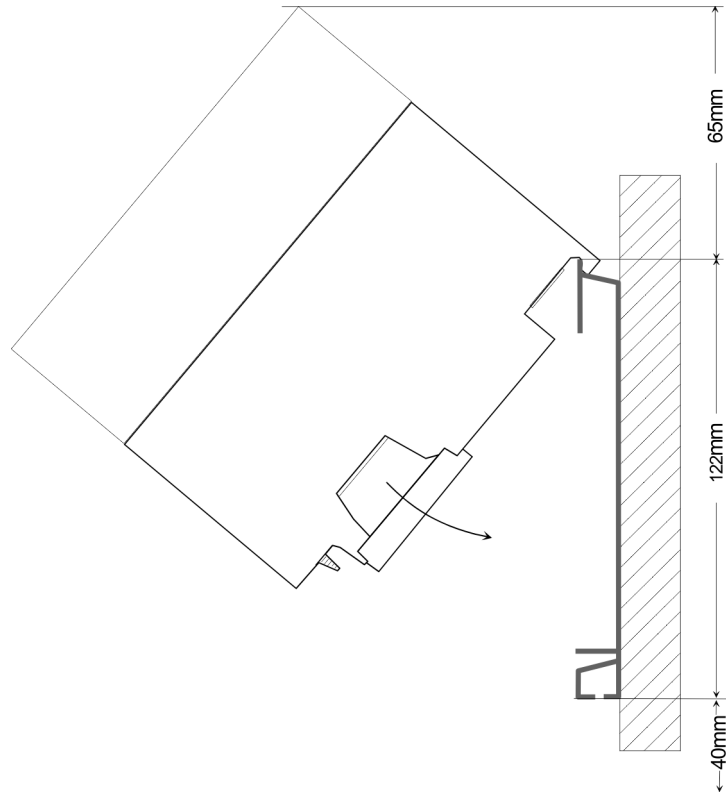

Installation dimensions

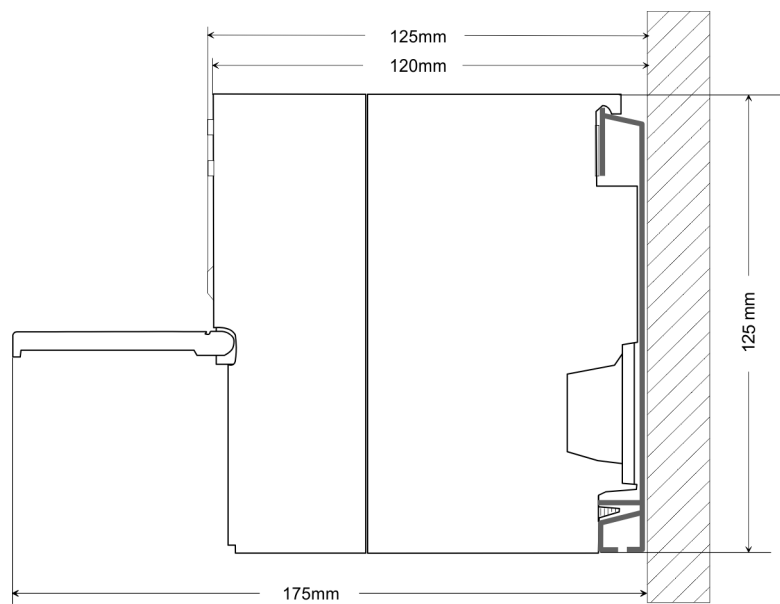

2.3 Installation at the profile rail

General

The single modules are directly installed on a profile rail and connected via the backplane bus connector. Before installing the modules you have to clip the backplane bus connector to the module from the backside. The backplane bus connector is delivered together with the peripheral modules.

Profile rail

Order number	A	B	C
390-1AB60	160	140	10
390-1AE80	482	466	8.3
390-1AF30	530	500	15
390-1AJ30	830	800	15
390-9BC00*	2000	Drillings only left	15

*) Unit pack: 10 pieces

Measures in mm

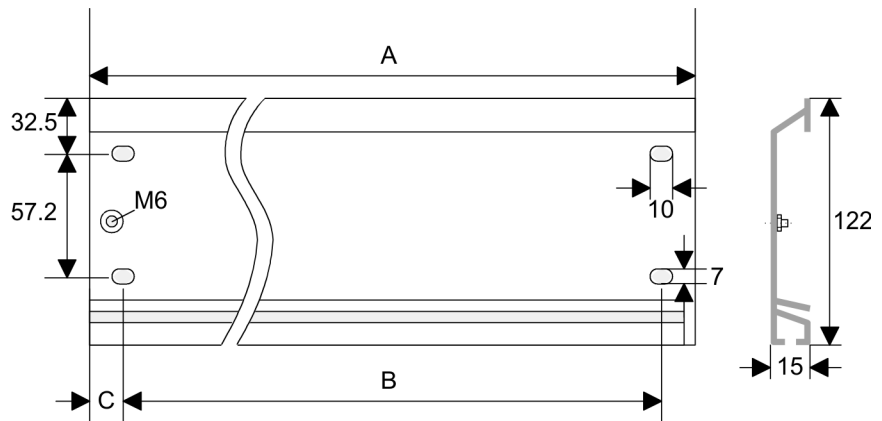

Bus connector

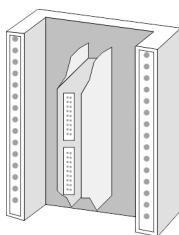

For the communication between the modules the System 300S uses a backplane bus connector. Backplane bus connectors are included in the delivering of the peripheral modules and are clipped at the module from the backside before installing it to the profile rail.

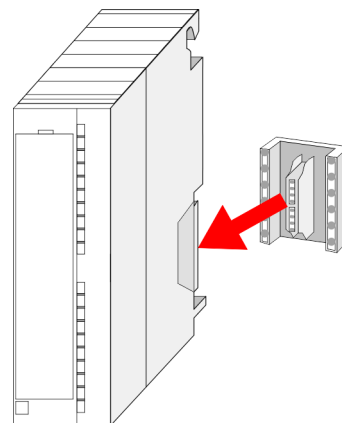

Installation at the profile rail

Assembly possibilities

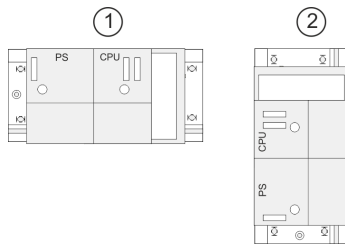

Please regard the allowed environment temperatures:

- 1 horizontal assembly: from 0 to 60°C
- 2 vertical assembly: from 0 to 40°C

The horizontal structure always starts at the left side with the power supply and the CPU, then you plug-in the peripheral modules beside to the right. You may plug-in maximum 32 peripheral modules to the CPU.

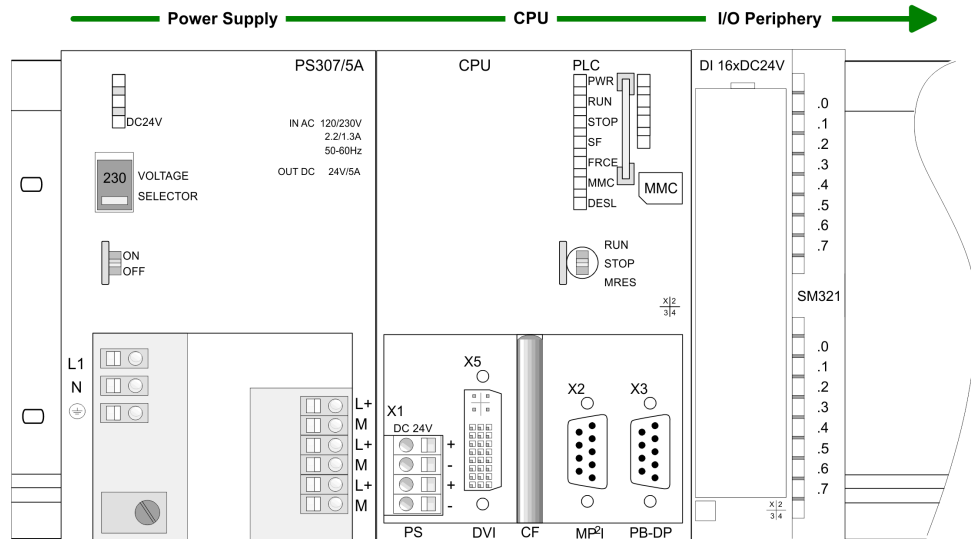

Approach

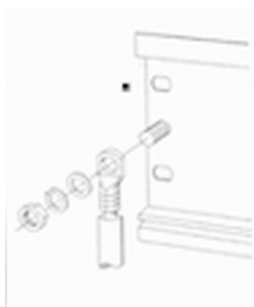

If you do not deploy SPEED-Bus modules, the assembly happens with the following approach:

1. Bolt the profile rail with the background (screw size: M6), so that you still have minimum 65mm space above and 40mm below the profile rail.
2. If the background is a grounded metal or device plate, please look for a low-impedance connection between profile rail and background.
3. Connect the profile rail with the protected earth conductor. For this purpose there is a bolt with M6-thread.
4. The minimum cross-section of the cable to the protected earth conductor has to be 10mm².
5. Stick the power supply to the profile rail and pull it to the left side to the grounding bolt of the profile rail.
6. Fix the power supply by screwing.
7. Take a backplane bus connector and click it at the CPU from the backside like shown in the picture.
8. Stick the CPU to the profile rail right from the power supply and pull it to the power supply.
9. Click the CPU downwards and bolt it like shown.
10. Repeat this procedure with the peripheral modules, by clicking a backplane bus connector, stick the module right from the modules you've already fixed, click it downwards and connect it with the backplane bus connector of the last module and bolt it.

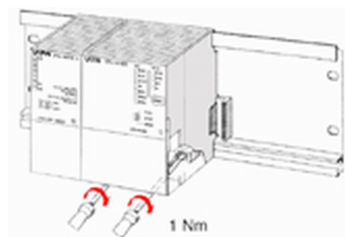
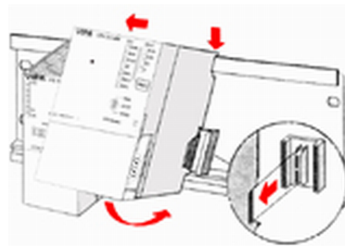

**CAUTION!**

- Before installing or overhauling the power supplies must be disconnected from voltage (pull the plug or remove the fuse)!
- Installation and modifications only by properly trained personnel!

2.4 Cabling

Overview

For the cabling of power supplies gray connectors with CageClamp technology are used.

**CAUTION!**

- The power supplies must be released before installation and repair tasks, i.e. before handling with the power supply or with the cabling you must disconnect current/voltage (pull plug, at fixed connection switch off the concerning fuse)!
- Installation and modifications only by properly trained personnel!

CageClamp technology (gray)

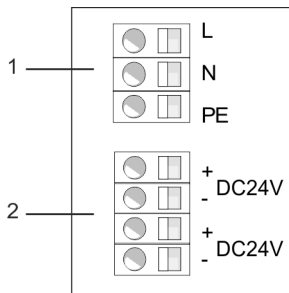

- 1 AC IN 100 ... 240V
- 2 DC OUT 24V

For the cabling of power supplies a green plug with CageClamp technology is deployed.

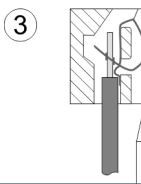
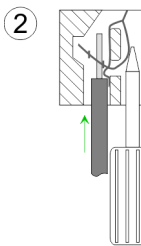
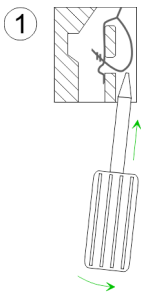

The picture on the left side shows the cabling step by step from top view. Here wires with a cross-section of 0.08mm² to 2.5mm² may be connected. You can use flexible wires without end case as well as stiff wires.

1. ➤ For cabling you push the locking vertical to the inside with a suiting screwdriver and hold the screwdriver in this position.
2. ➤ To open the contact spring you have to push the screwdriver in the opposite direction and hold it. Insert the de-isolated wire into the round opening.
3. ➤ By removing the screwdriver the wire is connected safely with the plug connector via a spring.

2.5 Installation guidelines

General	<p>The installation guidelines contain information about the interference free deployment of a PLC system. There is the description of the ways, interference may occur in your PLC, how you can make sure the electromagnetic compatibility (EMC), and how you manage the isolation.</p>
What does EMC mean?	<p>Electromagnetic compatibility (EMC) means the ability of an electrical device, to function error free in an electromagnetic environment without being interfered respectively without interfering the environment.</p> <p>The components of Yaskawa are developed for the deployment in industrial environments and meets high demands on the EMC. Nevertheless you should project an EMC planning before installing the components and take conceivable interference causes into account.</p>
Possible interference causes	<p>Electromagnetic interferences may interfere your control via different ways:</p> <ul style="list-style-type: none">■ Electromagnetic fields (RF coupling)■ Magnetic fields with power frequency■ Bus system■ Power supply■ Protected earth conductor <p>Depending on the spreading medium (lead bound or lead free) and the distance to the interference cause, interferences to your control occur by means of different coupling mechanisms.</p> <p>There are:</p> <ul style="list-style-type: none">■ galvanic coupling■ capacitive coupling■ inductive coupling■ radiant coupling
Basic rules for EMC	<p>In the most times it is enough to take care of some elementary rules to guarantee the EMC. Please regard the following basic rules when installing your PLC.</p> <ul style="list-style-type: none">■ Take care of a correct area-wide grounding of the inactive metal parts when installing your components.<ul style="list-style-type: none">– Install a central connection between the ground and the protected earth conductor system.– Connect all inactive metal extensive and impedance-low.– Please try not to use aluminium parts. Aluminium is easily oxidizing and is therefore less suitable for grounding.■ When cabling, take care of the correct line routing.<ul style="list-style-type: none">– Organize your cabling in line groups (high voltage, current supply, signal and data lines).– Always lay your high voltage lines and signal respectively data lines in separate channels or bundles.– Route the signal and data lines as near as possible beside ground areas (e.g. suspension bars, metal rails, tin cabinet).

- Proof the correct fixing of the lead isolation.
 - Data lines must be shielded.
 - Analog lines must be shielded. When transmitting signals with small amplitudes the one sided laying of the isolation may be favourable.
 - Cables for frequency inverters, servo and stepper motors must be shielded.
 - Lay the line isolation extensively on an isolation/protected earth conductor rail directly after the cabinet entry and fix the isolation with cable clamps.
 - Make sure that the isolation/protected earth conductor rail is connected impedance-low with the cabinet.
 - Use metallic or metallised plug cases for isolated data lines.
- In special use cases you should appoint special EMC actions.
 - Consider to wire all inductivities with erase links.
 - Please consider luminescent lamps can influence signal lines.
- Create a homogeneous reference potential and ground all electrical operating supplies when possible.
 - Please take care for the targeted employment of the grounding actions. The grounding of the PLC serves for protection and functionality activity.
 - Connect installation parts and cabinets with your PLC in star topology with the isolation/protected earth conductor system. So you avoid ground loops.
 - If there are potential differences between installation parts and cabinets, lay sufficiently dimensioned potential compensation lines.

Isolation of conductors

Electrical, magnetically and electromagnetic interference fields are weakened by means of an isolation, one talks of absorption. Via the isolation rail, that is connected conductive with the rack, interference currents are shunt via cable isolation to the ground. Here you have to make sure, that the connection to the protected earth conductor is impedance-low, because otherwise the interference currents may appear as interference cause.

When isolating cables you have to regard the following:

- If possible, use only cables with isolation tangle.
- The hiding power of the isolation should be higher than 80%.
- Normally you should always lay the isolation of cables on both sides. Only by means of the both-sided connection of the isolation you achieve high quality interference suppression in the higher frequency area. Only as exception you may also lay the isolation one-sided. Then you only achieve the absorption of the lower frequencies. A one-sided isolation connection may be convenient, if:
 - the conduction of a potential compensating line is not possible.
 - analog signals (some mV respectively μA) are transferred.
 - foil isolations (static isolations) are used.
- With data lines always use metallic or metallised plugs for serial couplings. Fix the isolation of the data line at the plug rack. Do not lay the isolation on the PIN 1 of the plug bar!
- At stationary operation it is convenient to strip the insulated cable interruption free and lay it on the isolation/protected earth conductor line.
- To fix the isolation tangles use cable clamps out of metal. The clamps must clasp the isolation extensively and have well contact.
- Lay the isolation on an isolation rail directly after the entry of the cable in the cabinet. Lead the isolation further on to your PLC and don't lay it on there again!



CAUTION!

Please regard at installation!

At potential differences between the grounding points, there may be a compensation current via the isolation connected at both sides.

Remedy: Potential compensation line

General data

2.6 General data

Conformity and approval		
Conformity		
CE	2014/35/EU	Low-voltage directive
	2014/30/EU	EMC directive
Approval		
UL		Refer to Technical data
others		
RoHS	2011/65/EU	Restriction of the use of certain hazardous substances in electrical and electronic equipment

Protection of persons and device protection		
Type of protection	-	IP20
Electrical isolation		
to the field bus	-	electrically isolated
to the process level	-	electrically isolated
Insulation resistance		-
Insulation voltage to reference earth		
Inputs / outputs	-	AC / DC 50V, test voltage AC 500V
Protective measures	-	against short circuit

Environmental conditions to EN 61131-2		
Climatic		
Storage / transport	EN 60068-2-14	-25...+70°C
Operation		
Horizontal installation hanging	EN 61131-2	0...+60°C
Horizontal installation lying	EN 61131-2	0...+40°C
Vertical installation	EN 61131-2	0...+40°C
Air humidity	EN 60068-2-30	RH1 (without condensation, rel. humidity 10...95%)
Pollution	EN 61131-2	Degree of pollution 2
Installation altitude max.	-	2000m
Mechanical		
Oscillation	EN 60068-2-6	1g, 9Hz ... 150Hz
Shock	EN 60068-2-27	15g, 11ms

Mounting conditions		
Mounting place	-	In the control cabinet
Mounting position	-	Horizontal and vertical

EMC	Standard	Comment	
Emitted interference	EN 61000-6-4	Class A (Industrial area)	
Noise immunity zone B	EN 61000-6-2	Industrial area	
		EN 61000-4-2	ESD 8kV at air discharge (degree of severity 3), 4kV at contact discharge (degree of severity 2)
		EN 61000-4-3	HF field immunity (casing) 80MHz ... 1000MHz, 10V/m, 80% AM (1kHz) 1.4GHz ... 2.0GHz, 3V/m, 80% AM (1kHz) 2GHz ... 2.7GHz, 1V/m, 80% AM (1kHz)
		EN 61000-4-6	HF conducted 150kHz ... 80MHz, 10V, 80% AM (1kHz)
		EN 61000-4-4	Burst, degree of severity 3
	EN 61000-4-5	Surge, degree of severity 3 *	

*) Due to the high-energetic single pulses with Surge an appropriate external protective circuit with lightning protection elements like conductors for lightning and overvoltage is necessary.

2.6.1 Use in difficult operating conditions



Without additional protective measures, the products must not be used in locations with difficult operating conditions; e.g. due to:

- *dust generation*
- *chemically active substances (corrosive vapors or gases)*
- *strong electric or magnetic fields*

3 Power supply PS 307

3.1 Safety Information

Application fields

The power supplies are constructed and manufactured for:

- DC 24V supply of System 300 components.
- Installation together with other System 300 components on one panel.
- Installation in a cubicle with air condition.
- Industrial usage.

Assembly

Using the power supply:

- Install the power supply together with your System 300 modules on a profile rail. In this case the power supply has to be plugged on the outermost rim of your System 300, because otherwise the backplane bus is interrupted.
- The power supplies are not connected to the backplane bus. When selecting the installation position please take care that the power supply is cooled sufficiently during operation.

In the following you will find the precautions you should take into account by using the System 300 power supplies.



CAUTION!

- The power supplies may only be installed in dry environment where it can only be accessed by trained personnel!
- The power supplies are not certified for explosive environments (EX-Zone)!
- Before installing or overhauling the System 300V, the power supplies must be disconnected from voltage (pull the plug or remove the fuse)!
- Installation and modifications only by properly trained personnel!
- Due to the compact design, the contact and fire protection to guarantee sufficient cooling can not be obeyed. For this reason the fire protection has to be guaranteed by the construction of the environment of the power supply (e.g. installation in a cubicle that obeys the fire protection rules)!
- The national rules and regulations of the respective country must be satisfied (installation, safety, EMC ...).

3.2 System overview

Power supplies

The System 300 power supplies presented here have an adjustable input voltage of AC 120/230V and an output voltage of DC 24V. Depending on the module, the voltage is adjusted via a 120 / 230V switch or automatically continuously from AC 100 ... 240V. For all the inputs and outputs are on the front and the module case is isolated to the back-plane bus, you may install the power supply together with your System 300 modules on a profile rail.

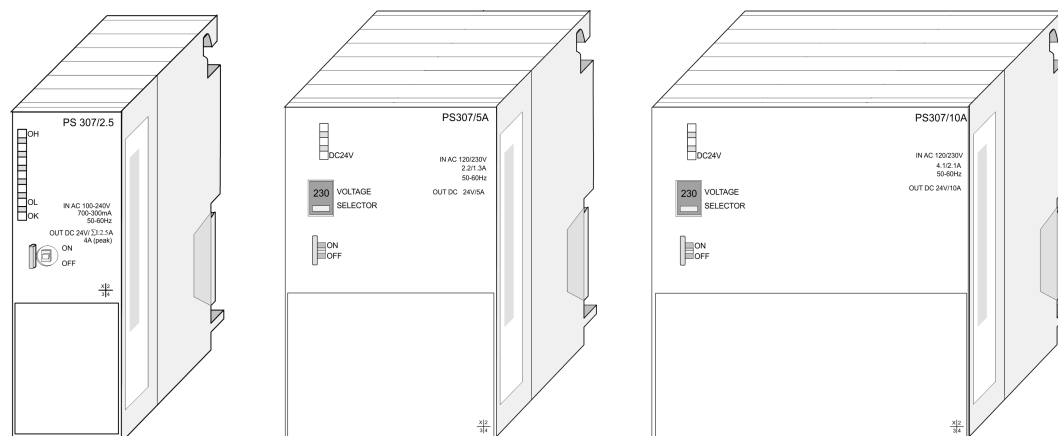

Order data

Type	Order number	Description
PS 307/2.5A	307-1BA00	Power supply primary AC 100...240V, secondary DC 24V, 2.5A
PS 307/5A	307-1EA00	Power supply primary AC 120/230V, secondary DC 24V, 5A
PS 307/10A	307-1KA00	Power supply primary AC 120/230V, secondary DC 24V, 10A

PS 307-1BA00

3.3 PS 307-1BA00

Properties

- Output current 2.5A
- Output voltage DC 24V
- Connection to single-phase AC mains Wide-range input AC 100...240V without manual switch
- Protection against short circuits, overloads and vacancy
- Useable together with System 300 on profile rail
- Safety isolation to EN 60950
- Protection against overheat
- Efficiency typ. 90% at I_{nom}
- May be used as load power supply

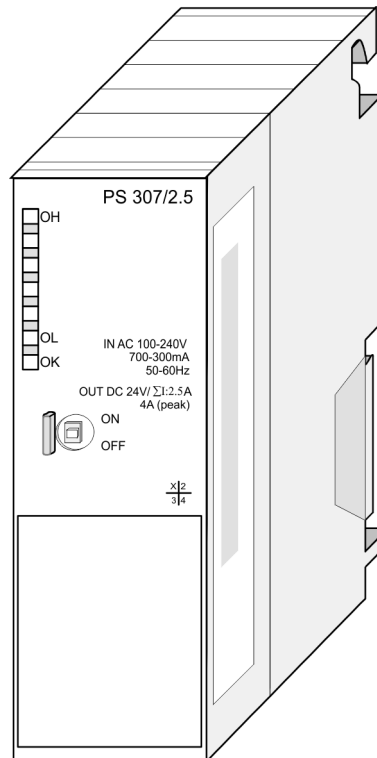

Order data

Type	Order number	Description
PS 307/2.5A	307-1BA00	Power supply primary AC 100...240V, secondary DC 24V, 2.5A

Structure

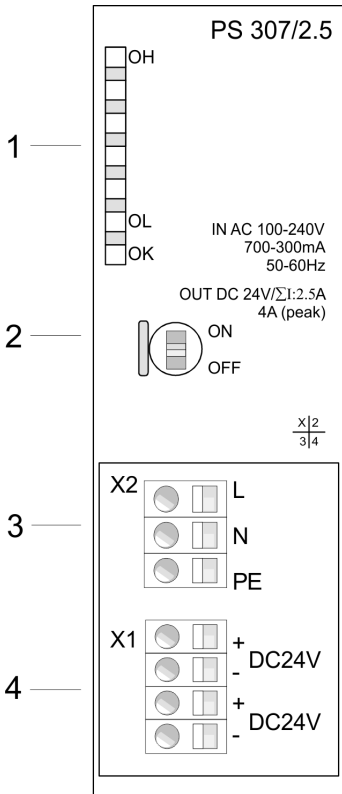

- 1 Status LED
- 2 ON/OFF switch
- The following components are beneath a flap:**
- 3 AC IN 100 ... 240V
- 4 DC OUT 24V, 2.5A



CAUTION!

- The power supplies must be released before installation and repair tasks, i.e. before handling with the power supply or with the cabling you must disconnect current/voltage (pull plug, at fixed connection switch off the concerning fuse)!
- Installation and modifications only by properly trained personnel!

Circuit diagram

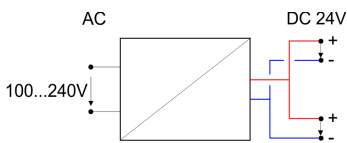

Input AC 100...240V

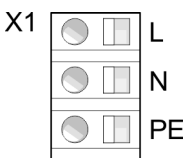

You have to provide the power supply with alternating voltage via the input slot. A melting fuse protects the input against overload.

Line protection

To protect the main supply lines, you should install a miniature circuit-breaker of the following rating:

- Rated current at AC 230V: 6A
- Tripping characteristics: C

PS 307-1BA00

Output DC 24V, 2.5A

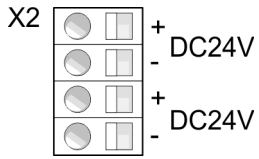

Here you may connect System 300 modules to two sockets, that need a external DC 24V voltage. Both outputs are protected against short circuits and have each an output voltage of DC 24V at a total current of max. 2.5A.

LEDs

On the front of the power supply there are 3 LEDs for error diagnostics. The following table shows the usage and the according colors.

LED	Color	Description
OH	red	Overheat: Is on when overheated.
OL	yellow	Overload: Is on when the total electricity exceeds the allowed maximum total electricity of approximately 4A.
OK	green	OK: Is on when there is no error and the DC 24V voltage supply is present.

Power derating curve

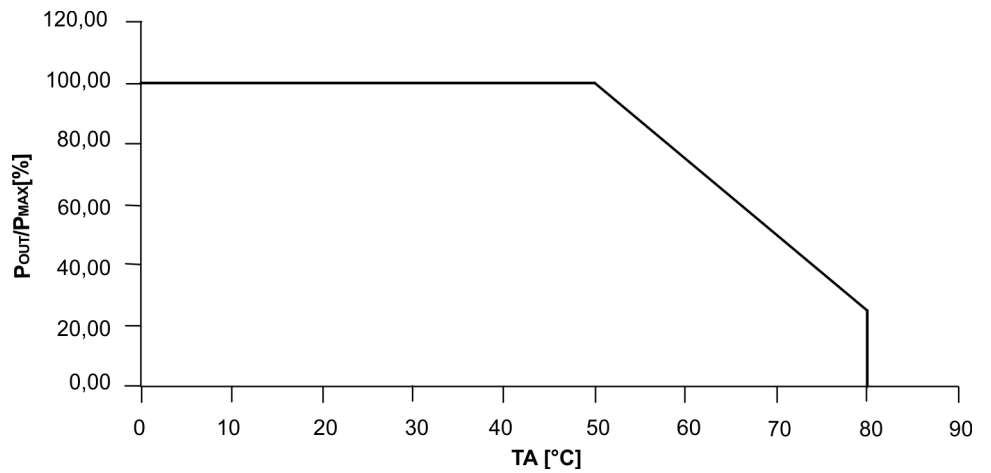

3.3.1 Technical data

Order no.	307-1BA00
Type	PS 307
SPEED-Bus	-
Technical data power supply	
Input voltage (rated value)	AC 100...240 V
Input voltage (permitted range)	AC 100...240 V
Mains frequency (rated value)	50...60 Hz
Mains frequency (permitted range)	47...63 Hz
Input current (at 120 V)	0.58 A
Input current (at 230 V)	0.29 A
Inrush current (at 25 °C)	30 A
I ² t	1 A ² s
Power consumption typ.	67 W
Output voltage (rated value)	24 V
Output current (rated value)	2.5 A
Power supply parallel switchable	-
Protect type	short circuits, overload, vacancy, over temperature (IP20)
Ripple of output voltage (max.), BW=20 MHz	150 mV
Efficiency typ.	90 %
Power loss typ.	6 W
Status information, alarms, diagnostics	
Status display	yes
Interrupts	no
Process alarm	no
Diagnostic interrupt	no
Diagnostic functions	no
Diagnostics information read-out	none
Supply voltage display	none
Group error display	none
Channel error display	none
Housing	
Material	PPE
Mounting	Rail System 300
Mechanical data	
Dimensions (WxHxD)	40 mm x 125 mm x 120 mm
Net weight	310 g

PS 307-1BA00 > Technical data

Order no.	307-1BA00
Weight including accessories	-
Gross weight	-
Environmental conditions	
Operating temperature	0 °C to 60 °C
Storage temperature	-25 °C to 70 °C
Certifications	
UL certification	-
KC certification	-

3.4 PS 307-1EA00

Properties

- Output current 5A
- Output voltage DC 24V
- Connection to single-phase AC mains AC 120/230V, 60/50Hz (switchable)
- Protection against short circuits, overloads and vacancy
- Useable together with System 300 on profile rail
- Safety isolation to EN 60950
- May be used as load power supply

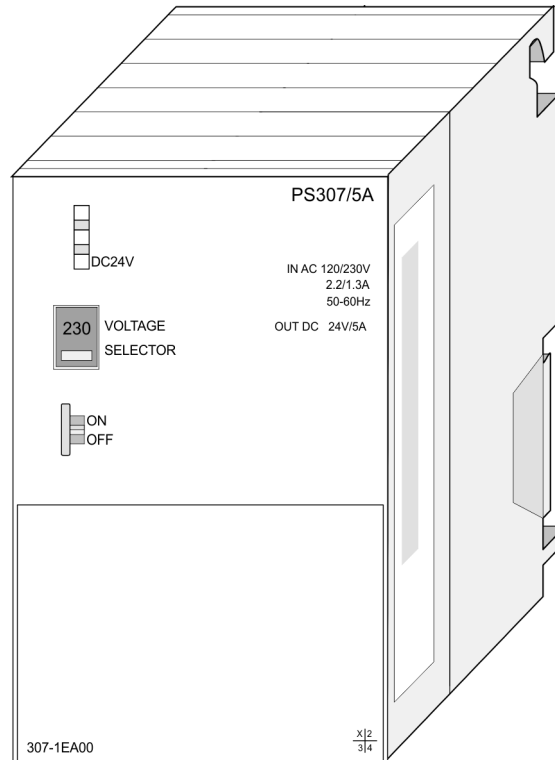

Order data

Typ	Order number	Description
PS 307/5A	307-1EA00	Power supply primary AC 120/230V, secondary DC 24V, 5A

Structure

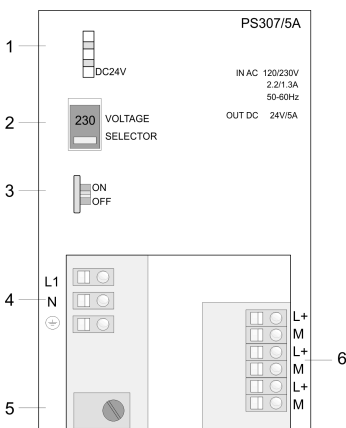

- 1 Status LED
 - 2 Mains voltage selector switch AC 120/230V
 - 3 ON/OFF switch
- The following components are beneath a flap:**
- 4 AC IN 120/230V
 - 5 Strain relief
 - 6 DC OUT 24V, 5A



CAUTION!

- The power supplies must be released before installation and repair tasks, i.e. before handling with the power supply or with the cabling you must disconnect current/voltage (pull plug, at fixed connection switch off the concerning fuse)!
- Installation and modifications only by properly trained personnel!

Circuit diagram

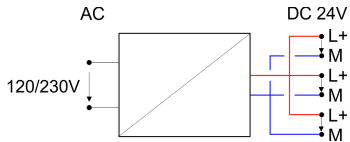

Input AC 120/230V

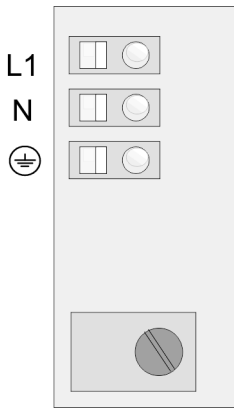

The power supply is provided with AC voltage by means of the input slot.



Please note before start-up that the input voltage corresponds to the adjusted value at the mains voltage selector switch!

The main supply cable should always be fixed by means of the strain relief!

Line protection

To protect the main supply lines, you should install a miniature circuit-breaker of the following rating:

- Rated current at AC 230V: 10A
- Tripping characteristics: C

Mains voltage selector switch

On delivery the power supply is adjusted to AC 230V input voltage. At the front side of the power supply there is a mains voltage selector switch to switch input voltage to AC 120V.

1. ➤ For this remove the transparent plastic cover by means of a screwdriver.
2. ➤ Now you can select the requested input voltage with the screwdriver, too.
3. ➤ Fix again the transparent plastic cover, now.

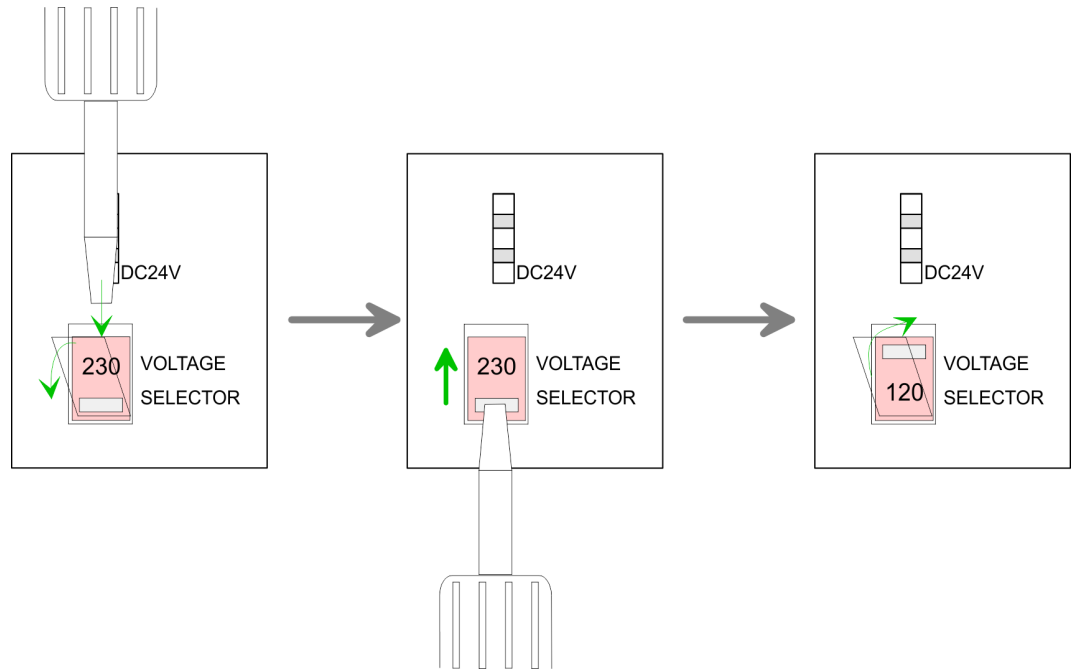

Output DC 24V, 5A

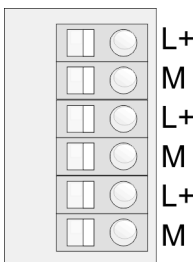

Here DC 24V can be picked up via triple terminal. The outputs are protected against short circuit. Please note that the sum current may not exceed maximally 5A.

LED

At the front there is a green LED labeled with "DC 24V" which serves the error diagnostics. The following conditions can be indicated:

LED	Description
<input checked="" type="checkbox"/> green	There is no error, DC 24V output voltage is present.
<input type="checkbox"/> off	There is a short circuit at the secondary side or undervoltage on primary side or the power supply is damaged.
<input checked="" type="checkbox"/> blinks	The sum of the individual currents exceeded the maximum total current of 5A.

**CAUTION!**

- Before installing or overhauling single components res. the whole system, the power supplies must be disconnected from voltage (pull the plug or remove the fuse)!
- Installation and modifications only by properly trained personnel!
- During operation the DC 24V LED is on. An error is indicated if the LED gets off or blinks.
- The usage out of the adjusted mains input voltage can damage the power supply.
- Durably exceeding the maximum total current the lifespan of the power supply is affected.

3.4.1 Technical data

Order no.	307-1EA00
Type	PS 307
SPEED-Bus	-
Technical data power supply	
Input voltage (rated value)	AC 120/230 V
Input voltage (permitted range)	AC 90...132/180...264 V
Mains frequency (rated value)	50...60 Hz
Mains frequency (permitted range)	47...63 Hz
Input current (at 120 V)	2.2 A
Input current (at 230 V)	1.3 A
Inrush current (at 25 °C)	45 A
I ² t	1.2 A ² s
Power consumption typ.	138 W
Output voltage (rated value)	24 V
Output current (rated value)	5 A
Power supply parallel switchable	-
Protect type	short circuits (electr.) non-latching, overload, vacancy
Ripple of output voltage (max.), BW=20 MHz	150 mV
Efficiency typ.	87 %
Power loss typ.	18 W
Status information, alarms, diagnostics	
Status display	yes
Interrupts	no
Process alarm	no
Diagnostic interrupt	no
Diagnostic functions	no
Diagnostics information read-out	none
Supply voltage display	none
Group error display	none
Channel error display	none
Housing	
Material	PPE
Mounting	Rail System 300
Mechanical data	
Dimensions (WxHxD)	80 mm x 125 mm x 120 mm
Net weight	610 g

Order no.	307-1EA00
Weight including accessories	-
Gross weight	-
Environmental conditions	
Operating temperature	0 °C to 60 °C
Storage temperature	-25 °C to 70 °C
Certifications	
UL certification	-
KC certification	yes

3.5 PS 307-1KA00

Properties

- Output current 10A
- Output voltage DC 24V
- Connection to single-phase AC mains AC 120/230V, 60/50Hz (switchable)
- Protection against short circuits, overloads and vacancy
- Useable together with System 300 on profile rail
- Safety isolation to EN 60950
- May be used as load power supply

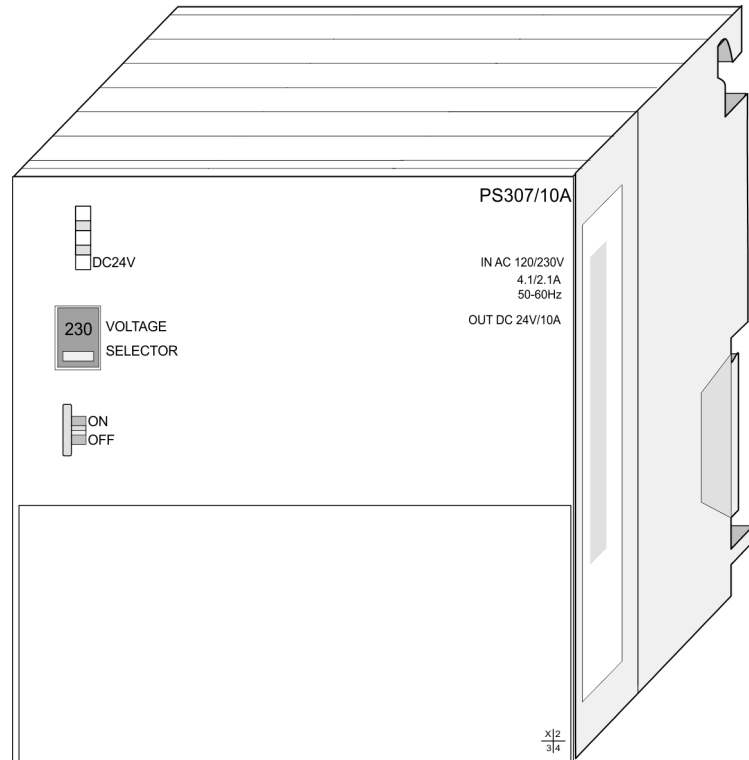

Order data

Type	Order number	Description
PS 307/10A	307-1KA00	Power supply primary AC 120/230V, secondary DC 24V, 10A

Structure

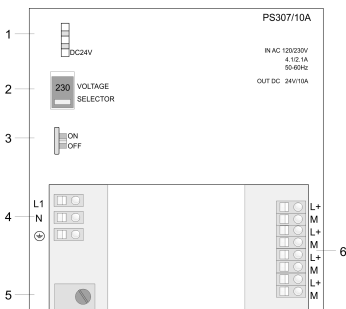

- 1 Status LED
 - 2 Mains voltage selector switch AC 120/230V
 - 3 ON/OFF switch
- The following components are beneath a flap:**
- 4 AC IN 120/230V
 - 5 Strain relief
 - 6 DC OUT 24V, 10A



CAUTION!

- The power supplies must be released before installation and repair tasks, i.e. before handling with the power supply or with the cabling you must disconnect current/voltage (pull plug, at fixed connection switch off the concerning fuse)!
- Installation and modifications only by properly trained personnel!

Circuit diagram

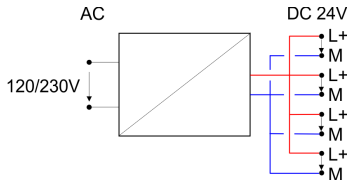

Input AC 120/230V

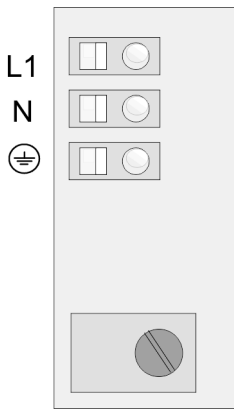

The power supply is provided with AC voltage by means of the input slot.



Please note before start-up that the input voltage corresponds to the adjusted value at the mains voltage selector switch!

The main supply cable should always be fixed by means of the strain relief!

Line protection

To protect the main supply lines, you should install a miniature circuit-breaker of the following rating:

- Rated current at AC 230V: 10A
- Tripping characteristics: C

Mains voltage selector switch

On delivery the power supply is adjusted to AC 230V input voltage. At the front side of the power supply there is a mains voltage selector switch to switch input voltage to AC 120V.

1. ➤ For this remove the transparent plastic cover by means of a screwdriver.
2. ➤ Now you can select the requested input voltage with the screwdriver, too.
3. ➤ Fix again the transparent plastic cover, now.

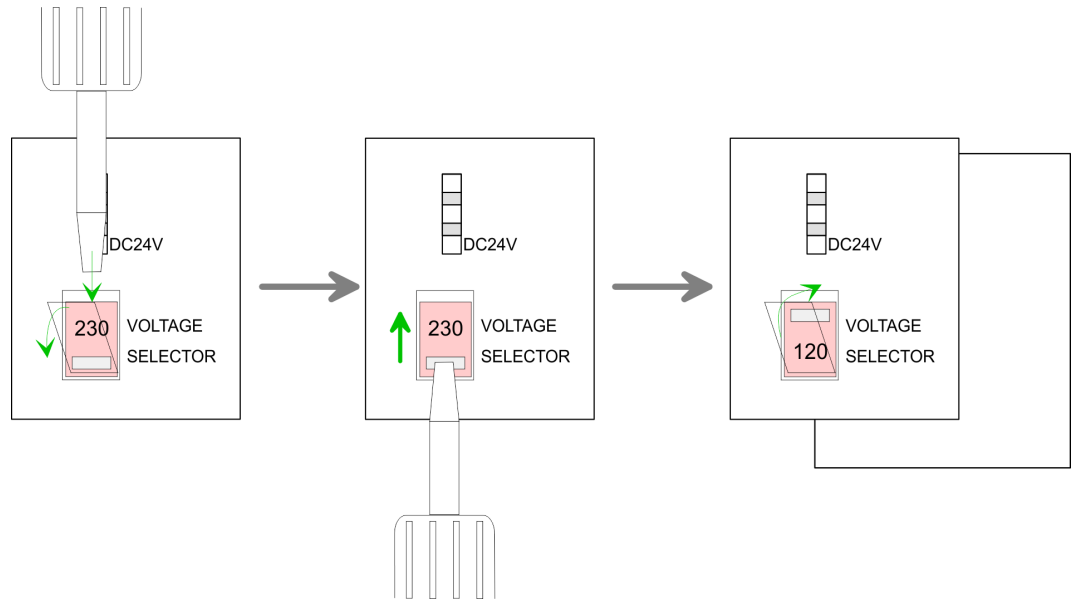

Output DC 24V, 10A

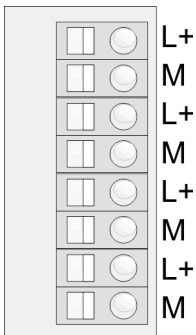

Here DC 24V can be picked up via quadruple terminal. The outputs are protected against short circuit. Please note that the sum current may not exceed maximally 10A.

LED

At the front there is a green LED labeled with "DC 24V" which serves the error diagnostics. The following conditions can be indicated:

LED	Description
<input checked="" type="checkbox"/> green	There is no error, DC 24V output voltage is present.
<input type="checkbox"/> off	There is a short circuit at the secondary side or undervoltage on primary side or the power supply is damaged.
<input checked="" type="checkbox"/> blinks	The sum of the individual currents exceeded the maximum total current of 10A.

**CAUTION!**

- Before installing or overhauling single components res. the whole system, the power supplies must be disconnected from voltage (pull the plug or remove the fuse)!
- Installation and modifications only by properly trained personnel!
- During operation the DC 24V LED is on. An error is indicated if the LED gets off or blinks.
- The usage out of the adjusted mains input voltage can damage the power supply.
- Durably exceeding the maximum total current the lifespan of the power supply is affected.

3.5.1 Technical data

Order no.	307-1KA00
Type	PS 307
SPEED-Bus	-
Technical data power supply	
Input voltage (rated value)	AC 120/230 V
Input voltage (permitted range)	AC 90...132/180...264 V
Mains frequency (rated value)	50...60 Hz
Mains frequency (permitted range)	47...63 Hz
Input current (at 120 V)	4.1 A
Input current (at 230 V)	2.1 A
Inrush current (at 25 °C)	55 A
I ² t	9 A ² s
Power consumption typ.	275 W
Output voltage (rated value)	24 V
Output current (rated value)	10 A
Power supply parallel switchable	-
Protect type	short circuits (electr.) non-latching, overload, vacancy
Ripple of output voltage (max.), BW=20 MHz	150 mV
Efficiency typ.	87 %
Power loss typ.	35 W
Status information, alarms, diagnostics	
Status display	yes
Interrupts	no
Process alarm	no
Diagnostic interrupt	no
Diagnostic functions	no
Diagnostics information read-out	none
Supply voltage display	none
Group error display	none
Channel error display	none
Housing	
Material	PPE
Mounting	Rail System 300
Mechanical data	
Dimensions (WxHxD)	120 mm x 125 mm x 120 mm
Net weight	1110 g

PS 307-1KA00 > Technical data

Order no.	307-1KA00
Weight including accessories	-
Gross weight	-
Environmental conditions	
Operating temperature	0 °C to 60 °C
Storage temperature	-25 °C to 70 °C
Certifications	
UL certification	-
KC certification	yes